







This sensor interface, which is compatible with the MX2001 suite of sensors, monitors changing water levels in a wide range of applications, including streams, lakes, wetlands, tidal areas, and groundwater. It is designed to work with the HOBOnet (HOBOnet® RX) Wireless Sensor Network in which data is transmitted wirelessly from the sensor mote across the network to the station and then uploaded to HOBOLink® cloud software. With HOBOLink, you can monitor sensor readings, view graphs, set up alarms, download data, and more.

## Specifications

### Wireless Mote

<b>Operating Temperature Range</b>	-25° to 60°C (-13° to 140°F) with rechargeable batteries -40° to 70°C (-40° to 158°F) with lithium batteries
<b>Radio Power</b>	12.6 mW (+11 dBm) non-adjustable
<b>Transmission Range</b>	Reliable connection to 457.2 m (1,500 ft.) line of sight at 1.8 m (6 ft.) high Reliable connection to 609.6 m (2,000 ft.) line of sight at 3 m (10 ft.) high
<b>Wireless Data Standard</b>	IEEE 802.15.4
<b>Radio Operating Frequencies</b>	RXW-WL-900: 904–924 MHz RXW-WL-868: 866.5 MHz RXW-WL-921: 921 MHz RXW-WL-922: 916–924 MHz
<b>Modulation Employed</b>	OQPSK (Offset Quadrature Phase Shift Keying)
<b>Data Rate</b>	Up to 250 kbps, non-adjustable
<b>Duty Cycle</b>	<1%
<b>Maximum Number of Motes</b>	Up to 50 wireless sensors or 336 data channels per one HOBOnet RX station
<b>Logging Rate</b>	1 minute to 18 hours
<b>Number of Data Channels</b>	4 (Water Level, Differential Pressure, Water Temperature, Barometric Pressure)
<b>Battery Type/Power Source</b>	Two AA 1.2V rechargeable NiMH batteries, powered by built-in solar panel or two AA 1.5V non-rechargeable lithium batteries for operating conditions of -40 to 70°C (-40 to 158°F)
<b>Battery Life</b>	With NiMH batteries: Typical 3–5 years when used in the temperature range -20° to 40°C (-4°F to 104°F) and positioned toward the sun (see <i>Mounting and Positioning the Mote</i> ); using the batteries outside this range reduces the battery life. With non-rechargeable lithium batteries: 1 year, typical use.
<b>Memory</b>	16 MB
<b>Dimensions</b>	Interface Connector Diameter: 25.4 mm (1 inch) Cable length: 1.83 m (6 ft) Mote: 16.2 x 8.59 x 4.14 cm (6.38 x 3.38 x 1.63 inches)
<b>Weight</b>	229 g (8.08 oz)
<b>Materials</b>	Sensor: Polycarbonate housing encasing epoxy sealed circuit board Cable: Polyurethane Mote: PCPBT, silicone rubber seal
<b>Environmental Rating</b>	Mote: IP67, NEMA 6
<b>Compliance Marks</b>	 RXW-WL-900: See last page.  RXW-WL-868: The CE Marking identifies this product as complying with all relevant directives in the European Union (EU).  RXW-WL-921: See last page.  RXW-WL-922: See last page.

### RXW Water Level Sensor

#### Models:

- RXW-WL-900 (US)
- RXW-WL-868 (Europe)
- RXW-WL-921 (Taiwan)
- RXW-WL-922 (Australia/NZ)

#### Included Items:

- Cable ties
- Screws

## Water Level Sensor

### Pressure (Absolute) and Water Level Measurements MX2001-01-SS-S and MX2001-01-Ti-S

<b>Operation Range</b>	0 to 207 kPa (0 to 30 psia); approximately 0 to 9 m (0 to 30 ft) of water depth at sea level, or 0 to 12 m (0 to 40 ft) of water at 3,000 m (10,000 ft) of altitude
<b>Factory Calibrated Range</b>	69 to 207 kPa (10 to 30 psia), 0° to 40°C (32° to 104°F)
<b>Burst Pressure</b>	310 kPa (45 psia) or 18 m (60 ft) depth
<b>Water Level Accuracy*</b>	Typical error: $\pm 0.05\%$ FS, 0.5 cm (0.015 ft) water Maximum error: $\pm 0.1\%$ FS, 1.0 cm (0.03 ft) water
<b>Raw Pressure Accuracy**</b>	$\pm 0.3\%$ FS, 0.62 kPa (0.09 psi) maximum error
<b>Resolution</b>	<0.02 kPa (0.003 psi), 0.21 cm (0.007 ft) water
<b>Pressure Response Time (90%)***</b>	<1 second at a stable temperature

### Pressure (Absolute) and Water Level Measurements MX2001-02-SS-S

<b>Operation Range</b>	0 to 400 kPa (0 to 58 psia); approximately 0 to 30.6 m (0 to 100 ft) of water depth at sea level, or 0 to 33.6 m (0 to 111 ft) of water at 3,000 m (10,000 ft) of altitude
<b>Factory Calibrated Range</b>	69 to 400 kPa (10 to 58 psia), 0° to 40°C (32° to 104°F)
<b>Burst Pressure</b>	500 kPa (72.5 psia) or 40.8 m (134 ft) depth
<b>Water Level Accuracy*</b>	Typical error: $\pm 0.05\%$ FS, 1.5 cm (0.05 ft) water Maximum error: $\pm 0.1\%$ FS, 3.0 cm (0.1 ft) water
<b>Raw Pressure Accuracy**</b>	$\pm 0.3\%$ FS, 1.20 kPa (0.17 psi) maximum error
<b>Resolution</b>	<0.04 kPa (0.006 psi), 0.41 cm (0.013 ft) water
<b>Pressure Response Time (90%)***</b>	<1 second at a stable temperature

### Pressure (Absolute) and Water Level Measurements MX2001-03-SS-S

<b>Operation Range</b>	0 to 850 kPa (0 to 123.3 psia); approximately 0 to 76.5 m (0 to 251 ft) of water depth at sea level, or 0 to 79.5 m (0 to 262 ft) of water at 3,000 m (10,000 ft) of altitude
<b>Factory Calibrated Range</b>	69 to 850 kPa (10 to 123.3 psia), 0° to 40°C (32° to 104°F)
<b>Burst Pressure</b>	1,200 kPa (174 psia) or 112 m (368 ft) depth
<b>Water Level Accuracy*</b>	Typical error: $\pm 0.05\%$ FS, 3.8 cm (0.125 ft) water Maximum error: $\pm 0.1\%$ FS, 7.6 cm (0.25 ft) water
<b>Raw Pressure Accuracy**</b>	$\pm 0.3\%$ FS, 2.55 kPa (0.37 psi) maximum error
<b>Resolution</b>	<0.085 kPa (0.012 psi), 0.87 cm (0.028 ft) water
<b>Pressure Response Time (90%)***</b>	<1 second at a stable temperature

### Pressure (Absolute) and Water Level Measurements MX2001-04-SS-S and MX2001-04-Ti-S

<b>Operation Range</b>	0 to 145 kPa (0 to 21 psia); approximately 0 to 4 m (0 to 13 ft) of water depth at sea level, or 0 to 7 m (0 to 23 ft) of water at 3,000 m (10,000 ft) of altitude
<b>Factory Calibrated Range</b>	69 to 145 kPa (10 to 21 psia), 0° to 40°C (32° to 104°F)
<b>Burst Pressure</b>	310 kPa (45 psia) or 18 m (60 ft) depth
<b>Water Level Accuracy*</b>	Typical error: $\pm 0.075\%$ FS, 0.3 cm (0.01 ft) water Maximum error: $\pm 0.15\%$ FS, 0.6 cm (0.02 ft) water
<b>Raw Pressure Accuracy**</b>	$\pm 0.3\%$ FS, 0.43 kPa (0.063 psi) maximum error
<b>Resolution</b>	<0.014 kPa (0.002 psi), 0.14 cm (0.005 ft) water
<b>Pressure Response Time (90%)***</b>	<1 second at a stable temperature

**Barometric Pressure (RXW-WL-xxx)**

<b>Operation Range</b>	66 to 107 kPa (9.57 to 15.52 psia)
<b>Temperature Calibrated Range</b>	-20 to 50°C (-4 to 122°F)
<b>Accuracy</b>	±0.2 kPa (±0.029 psi) over full temperature range at fixed pressure; maximum error ±0.5% FS
<b>Water Level Accuracy*</b>	Typical error: ±0.075% FS, 0.3 cm (0.01 ft) water Maximum error: ±0.15% FS, 0.6 cm (0.02 ft) water
<b>Resolution</b>	<0.01 kPa (0.0015 psi)
<b>Response Time</b>	<1 second at stable temperature
<b>Stability (Drift)</b>	<0.01 kPa (0.0015 psi) per year

**Temperature Measurements (All Sensor End Models MX2001-0x-SS-S and MX2001-0x-Ti-S)**

<b>Operation Range</b>	-20° to 50°C (-4° to 122°F)
<b>Accuracy</b>	±0.44°C from 0° to 50°C (±0.79°F from 32° to 122°F), see Plot A
<b>Resolution</b>	0.1°C at 25°C (0.18°F at 77°F), see Plot A
<b>Response Time (90%)</b>	5 minutes in water (typical)
<b>Stability (Drift)</b>	0.1°C (0.18°F) per year

- \* Water Level Accuracy: With accurate reference water level measurement, known water density, and a stable temperature environment. System Water Level Accuracy equals the sum of the Barometric Water Level Accuracy plus the selected sensor end Water Level Accuracy.
- \*\* Raw Pressure Accuracy: Absolute pressure sensor accuracy includes all sensor drift, temperature, and hysteresis-induced errors.
- \*\*\* Changes in Temperature: Allow 20 minutes in water to achieve full temperature compensation of the pressure sensor. There can be up to 0.5% of additional error due to rapid temperature changes. Measurement accuracy also depends on temperature response time.

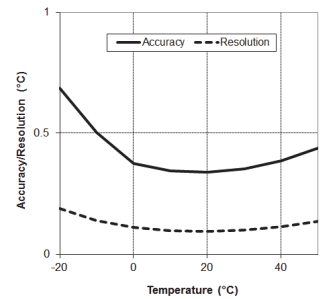

**Mote Components and Operation**

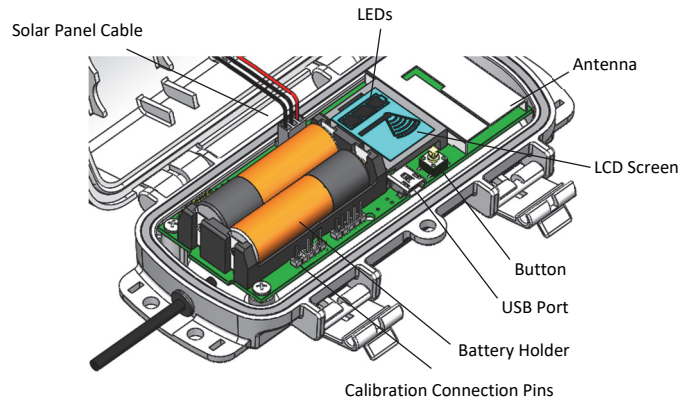
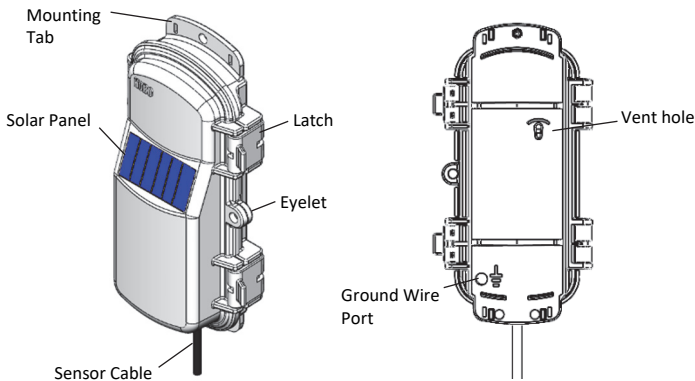

**Sensor Mote Opened**

- Mounting Tab:** Use the tabs at the top and bottom of the mote to mount it (see *Mounting and Positioning the Mote*).
- Solar Panel:** Position the solar panel towards the sun to charge the batteries (see *Mounting and Positioning the Mote*).
- Sensor Cable:** This cable connects the mote to the sensor.
- Eyelet:** Use this eyelet to attach a 3/16 inch padlock to the mote for security.
- Latch:** Use the two latches to open and close the mote door.
- Ground Wire Port:** Use this port to connect a ground wire (see *Mounting and Positioning the Mote*).
- Antenna:** This built-in antenna provides radio communications across the RX Wireless Sensor Network.

**LEDs:** There are two LEDs to the left of the LCD screen. The green LED blinks during the process of joining a network, blinking quickly while the mote searches for a network and then slowly as the mote registers with the network. Once the network registration process is complete, the blue LED blinks at 4 seconds to indicate normal operation. If the mote is not currently part of a network, the blue LED will be off. If the blue LED is on and not blinking, there is a problem with the mote. Contact Onset Technical Support.

**Solar Panel Cable:** This cable connects the built-in solar panel to the mote circuitry.

**Battery Holder:** The location where the batteries are installed as shown (see *Battery Information*).

**Calibration Connection Pins:** Use these pins to connect a programming tool. See *Performing a Soil-Specific Calibration* for details.

**USB Port:** Use this port to connect to the mote to a computer via USB cable if you need to update the firmware (see *Updating Mote Firmware*).

**Button:** Push this button for 1 second to illuminate the LCD or 3 seconds for the mote to search for a HOBONet Wireless Sensor Network to join (see *Adding the Mote to the HOBONet Wireless Sensor Network*).

**LCD Screen:** The mote is equipped with an LCD screen that displays details about the current status. The following example shows all symbols illuminated on the LCD screen followed by definitions of each symbol in the table.



LCD Symbol	Description
	The battery indicator shows the approximate battery charge remaining.
	This is a signal strength indicator. The more bars, the stronger the signal between motes. If there is no x icon next to the signal strength indicator, then the mote is part of a HOBONet Wireless Sensor Network.
	An empty signal strength icon plus the x icon indicates that the mote is not currently part of a network. See <i>Adding the Mote to the HOBONet Wireless Sensor Network</i> for details on how to add a mote to the network.
	When the mote is in the process of joining a network, the signal strength icon will blink and then the bars in the icon will cycle from left to right. The x icon will blink during the last step in the network registration process (see <i>Adding the Mote to the HOBONet Wireless Sensor Network</i> for details).
	This indicates a problem with the sensor itself (the mote is operational). Check the sensor and make any adjustments to it as needed. Contact Onset Technical Support if the problem persists.

### Adding the Mote to the HOBONet Wireless Sensor Network

The mote must join a HOBONet Wireless Sensor Network before it can begin measuring water level and transmitting data. This requires that you have access to the RX Station and the mote at the same time; we recommend that you complete these steps before deploying the mote.

**Important:** If you are setting up a new RX Station, follow the instructions in the station quick start before setting up this mote (go to [www.onsetcomp.com/support/manuals/24380-man-rx2105-rx2106-qsg](http://www.onsetcomp.com/support/manuals/24380-man-rx2105-rx2106-qsg) for RX2105 and RX2106 stations or go to [www.onsetcomp.com/support/manuals/18254-MAN-QSG-RX3000](http://www.onsetcomp.com/support/manuals/18254-MAN-QSG-RX3000) for RX3000 stations).

To add a mote to the network using the RX Station:

1. If the LCD is blank on the station, press any button to wake it up.
2. Press the Select button once (the number of smart sensors is displayed above Channels). Press Select again to switch to the module with the manager.

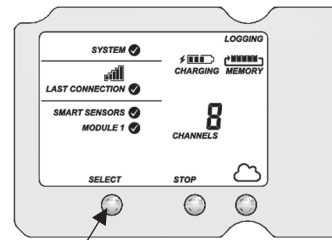

Press this button to view the module

3. Press the Search button (the magnifying glass). The magnifying glass icon blinks while the station is searching.

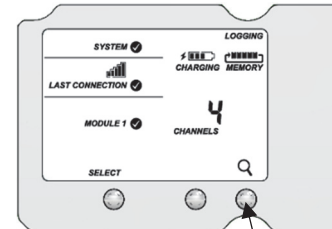

Press this button to search for motes to join the network

4. Connect the interface connector to the sensor with the direct-read cable in between as shown here. The end of the cable with the longer housing connects to the interface connector as shown below.

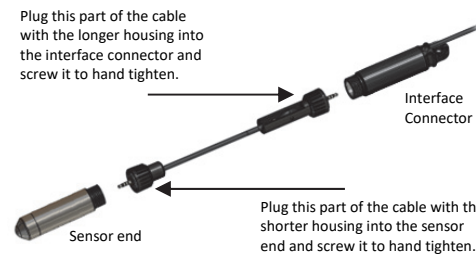

5. Open the mote door and install the batteries if you have not already done so.

- Press the button on the mote for 3 seconds. The signal strength icon flashes and then cycles.

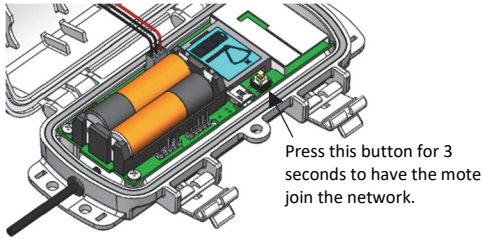

- Watch the LCD on the mote.

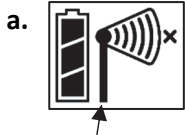

This signal strength icon blinks while the mote searches for a network.



Once the mote finds a network, the icon stops flashing. The bars cycle from left to right.



This network connection "x" icon blinks while the mote completes the registration process, which may take up to five minutes.



Once the mote has finished joining the network, the "x" icon disappears and the channel count on the station LCD increases by the total channel count for that sensor model.

The green LED blinks quickly while the mote searches for a network to join and then blinks slowly while it completes the network registration. Once the mote has finished joining the network, the green LED turns off and the blue LED then blinks indefinitely while the mote is part of the network.

**Note:** If the mote cannot find the network or has trouble remaining connected during this process, make sure the mote is in a vertical, upright position and within range of the station.

- Press the Search button (the magnifying glass) on the station to stop searching for motes.

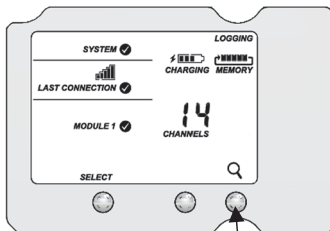

Press this button again to stop searching for motes.

If you added more than one mote to the network, then the total channel count on the station LCD for the manager module represents all measurement channels plus a battery channel for each mote in the network.

Sensor measurements are recorded at the logging interval specified in HOBOLink, transmitted to the station, and uploaded to HOBOLink at the next connection interval (readout).

## Mounting and Positioning the Sensor Node

- Position the sensor node towards the sun, making sure the solar panel is oriented so that it receives optimal sunlight throughout each season. You may need to periodically adjust the position of the sensor node as the path of the sunlight changes throughout the year or if tree and leaf growth alters the amount of sunlight reaching the solar panel.
- Make sure the sensor node is mounted a minimum of 1.8 m (6 feet) from the ground or vegetation to help maximize distance and signal strength.
- Consider using plastic poles such as PVC to mount the sensor node as certain types of metal could decrease the signal strength.
- Place the sensor node so there is full line of sight with the next sensor node. Use a repeater if there is an obstruction between sensor nodes.
- There should not be more than five sensor nodes in any direction from a repeater or the manager. Data from sensor nodes travels or "hops" across the network and may not reach the station if the sensor node is more than five hops away.

## Deploying the Water Level Sensor

**Warning:** Do not suspend anything from the 6-foot cable. The 6-foot cable is not designed to support the weight of the direct-read cable and sensor.

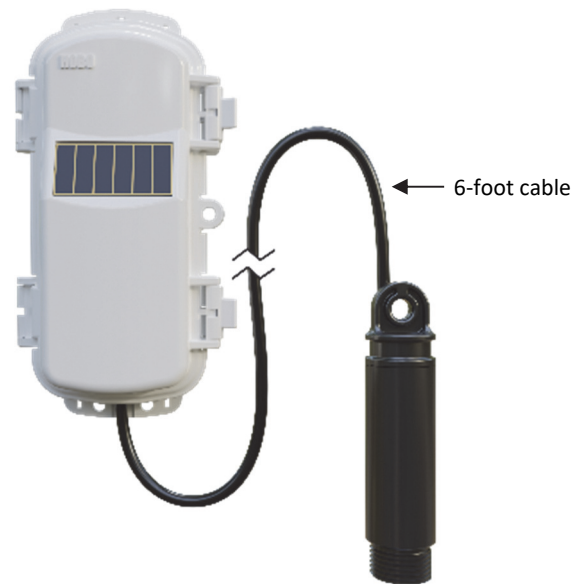

**Suspending the direct-read cable and water level sensor**

- **Option 1 (preferred): Using the long direct-read cable (CABLE-DR-xxx) and a compatible well-cap**

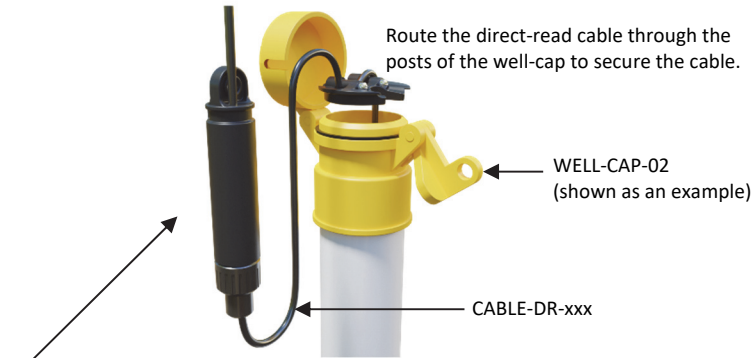

**Note:** If you choose this option, the interface connector is outside of the well.

- **Option 2: Using the mounting hole on the endcap**

The endcap contains a loop that allows you to use a carabiner (rated to 50 lbs. or greater) or some other reliable method to suspend the interface connector.

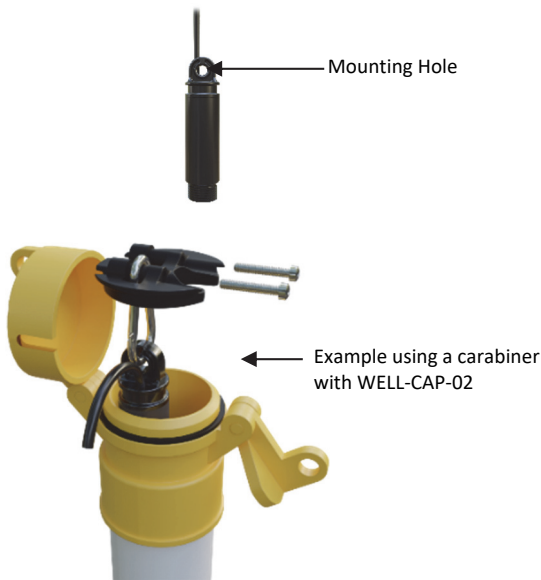

**Water Level Scaling in HOBOLink**

The following sections provide information on how to measure the reference water level and account for water density.

**Scenario 1: Setting a Reference Water Level**

1. Deploy the water level sensor in water and secure it in position (for example, hang it in a well).
2. Make sure your RX Station is logging and connecting fast enough for you to see the current water depth readings. (Press connect on the RX Station to see the latest logged value).

3. Enable Scaling for the HOBOnet water level sensor. In HOBOLink:
  - a. Select Devices, RX Devices, then select your station.
  - b. Select the wrench at the top of the page and select Module/Sensor Configuration from the menu.
  - c. Select Water Level for the appropriate sensor. On the right side of the page, ensure that *Enable Scaling* is selected.

**Sensor Configuration**

Latest Value: -0.1036 feet

Label:

Enable Graph

Enable Scaling

\*Scaled Units: feet = \*Multiplier: 1 x Value + \*Offset: 0

\*Scaled Measurement Type: Water Level at Pump 1

Serial Number: 21865450-1 Product Code: RXW-WL

4. Enter the scaling values:
  - a. Enter the Scaled Units: for example meters or feet. This should match the units shown in Latest Value, or you will need to adjust the multiplier to convert.
  - b. Enter the multiplier in the Multiplier field.

	Multiplier*
Fresh water	1
Brackish water	0.99
Salt water	0.9765

- c. Enter 0 in the Offset field for now.
  - d. Enter the Scaled Measurement Type, for example "Pond Water Level".
5. Click save and note the Latest Value.
  6. Take a reference water level measurement.
    - Note this as a negative number if the water level surface is *below* the reference point, such as groundwater level referenced to the top of the well (**Figure 1**).
    - Note this as a positive number if the water level surface is *above* the reference point, such as the bottom of the stream or the zero on a staff gauge (**Figure 2**).
  7. Calculate the offset, which is equal to the reference water level reading (from step 6) minus the current water depth reading (from HOBOLink in step 5).
  8. Enter the calculated offset in the Offset field.
  9. Click save.
  10. Verify latest value matches the correct water level.

Latest Value: -100.0000 feet

Label:

Enable Graph

Enable Scaling

\*Scaled Units: feet = \*Multiplier: 1 x Value + \*Offset: -99.8964

\*Scaled Measurement Type: Water Level at Pump 1

**Scenario 2: Measuring Water Depth** (Figure 3)

1. Ensure the water level sensor is in the air.
2. Make sure your RX Station is logging and connecting fast enough for you to see the current water depth readings. (Press connect on the RX Station to see the latest logged value).
3. Enable Scaling for the HOBONet water level sensor. In HOBOLink:
  - a. Select Devices, RX Devices, then select your station.
  - b. Select the wrench at the top of the page and select Module/Sensor Configuration from the menu.
  - c. Select Water Level for the appropriate sensor. On the right side of the page, ensure that *Enable Scaling* is selected. (Refer to the screen shot in step 3 of the previous section.)
4. Enter the scaling values:
  - a. Enter the Scaled Units: for example meters or feet. This should match the units shown in Latest Value, or you will need to adjust the multiplier to convert.
  - b. Enter the multiplier in the Multiplier field.

	<b>Multiplier*</b>
<b>Fresh water</b>	1
<b>Brackish water</b>	0.99
<b>Salt water</b>	0.9765

- c. Enter 0 in the Offset field for now.
  - d. Enter the Scaled Measurement Type, for example "Pond Water Level".
5. Click save and note the Latest Value.
6. Calculate the offset, which is equal to zero minus the current water depth reading (from step 5).
7. Enter the calculated offset in the Offset field.
8. Click save. Latest value should be zero.
9. Deploy the water level sensor in water and secure it in position (for example, hang it in a well).

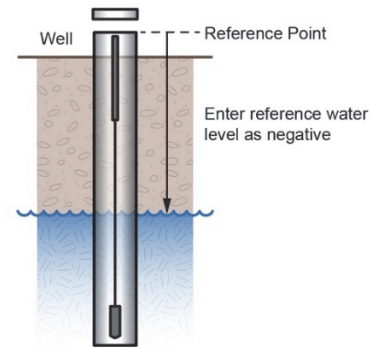

Figure 1: Water level is below reference point

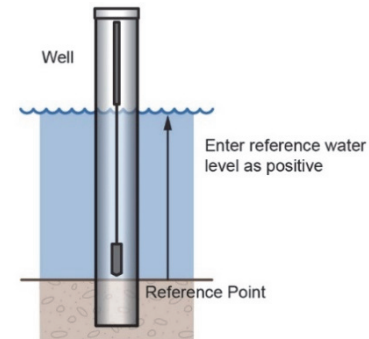

Figure 2: Water level is above reference point

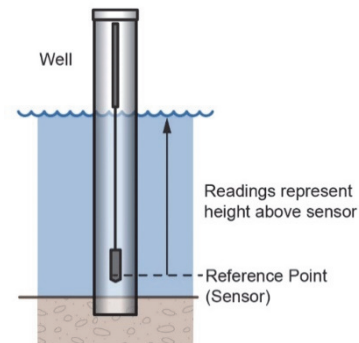

Figure 3: Water level is above pressure sensor

\*The **Multiplier** represents the density of the water, which is a function of its salinity. This is equal to 1 divided by the true density of the water in g/cm<sup>3</sup> (e.g., 1/1.025 for typical salt water).

**General Guidelines**

- The absolute pressure sensor in the water level sensor is temperature compensated over the range of 0° to 40°C (32° to 104°F). The barometric pressure sensor is temperature compensated over the range of -20° to 50°C (-4° to 122°F). To obtain the highest level of accuracy, both the sensor and station should be allowed to come to full temperature equilibrium (approximately 20 minutes) before the reference level is entered in HOBOLink as described in *Setting up the Station*.
- Sudden temperature changes should be avoided.
- When deploying the water level sensor in a well, make sure the well is vented to the atmosphere. Typically, a small hole can be drilled in the side of the well cap to

ensure that the pressure inside and outside the well is at equilibrium. Use the Onset well cap (WELL-CAP-02) if it is a 5 cm (2 inch) well. Otherwise, you will need to find another method of attaching the cable at the top of your well so that the sensor stays in position. The sensor cable includes a Kevlar® strength member so it can support the weight of the sensor and its cable. You can attach a clamp around the cable, such as a hose clamp, but be careful not to damage the cable.

- There is a vent for the barometric sensor on the back of the mote. This vent must not collect water or it will block proper barometric pressure readings. The best way to avoid water collecting is to mount the station vertically.
- The sensor face located in the nose cone of the sensor end needs to be in the water to measure water level.

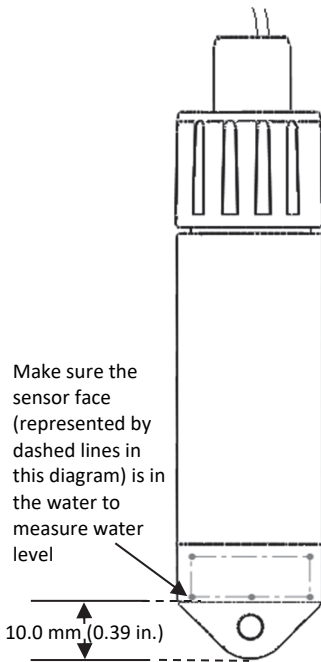

- Any change in length of the sensor cable will result in a 1-to-1 corresponding error in the depth measurement. Always pull-test a cable prior to deploying a sensor in a well to make sure it does not stretch.
- If you are deploying the sensor in a lake, river, or stream, you must first build a stilling well to protect it and the cable. A simple stilling well can be constructed with PVC or ABS pipe. A properly constructed stilling well holds the sensor in position and protects the sensor from currents, wave action, and debris. Suspend the sensor in the stilling well so it is always underwater, but not on the bottom to be buried by silt.



For more information, see the Technical Application Note for How to Build a Stilling Well at:

<https://www.onsetcomp.com/resources/tech-notes/how-to-build-stilling-well>

- To prevent the sensor from moving in currents and to ensure the support cable is kept straight during deployment, you may need to add a weight to the suspension cable just above the sensor or hang a weight below the sensor. In some cases, you may need to both add a weight and use a stilling well.
- Be very careful not to exceed the burst pressure for the sensor. The pressure sensor will burst if the maximum depth is exceeded (see *Specifications*). The sensor should be positioned at a depth where it will remain in the water for the duration of the deployment, but not exceed the rated bursting depth.
- If the cable is too long, loop the cable and secure the cable with multiple zip ties to ensure the loop does not slip. The looped cable should be tight enough that the cable can be easily pulled out of the well if necessary, but it must not bend the cable any tighter than a 1.25 cm (0.5 inch) radius to prevent damage to the cable.

## Updating Mote Firmware

If a new firmware version is available for the mote, use HOBOLink to download the file to your computer.

1. In HOBOLink, go to Devices, then RX Devices, and select the name of your station.
2. On the station page, click Overview and scroll down to Device Information.
3. Click the Wireless tab. This icon  appears next to the mote if there is a new version of firmware available.
4. Click the firmware  upgrade link. Click Download and save the firmware .bin file to your computer.
5. Connect the mote to the computer with a USB cable (open the mote door and use the USB port to the right of the LCD). The blue LED is illuminated while connected.
6. The mote appears as a new storage device in the computer's file storage manager. Copy the downloaded firmware file to the new storage device (the mote). The blue LED will blink slowly while the file is copying.
7. After the file is copied to the mote, the LED will stop blinking and remain a steady blue. Eject the storage device from the computer and disconnect the cable from the mote. The firmware installation process will begin automatically on the mote. The blue LED will blink rapidly while the firmware is installed. Once the firmware installation is complete, the LCD symbols return and the mote will automatically rejoin the network.

### Notes:

- Mac® users: A message may appear indicating the disk has not ejected properly when disconnecting the mote from the computer. The mote is operational and you can ignore the message.
- If the blue LED turns off abruptly while copying the file or installing the firmware, a problem has occurred. Contact Onset Technical Support for help.

## Battery Information

The mote uses two 1.2 V rechargeable NiMH batteries, charged by the built-in solar panel. The quality and quantity of solar light can affect whether the battery is sufficiently charged to last through the night and cloudy periods. Make sure the mote is placed in a location that will receive several hours of sunlight each day. If the mote does not receive enough sunlight to recharge the batteries, the battery life is estimated at 3–4 months. When batteries are regularly recharged, expected battery life is estimated at 3–5 years. Battery life varies based on the ambient temperature where the mote is deployed, the logging interval, the number of tripped alarms, and other factors. Deployments in extremely cold or hot temperatures can impact battery life. Estimates are not guaranteed due to uncertainties in initial battery conditions and operating environment.

Mote operation will stop when battery voltage drops to 1.8 V. Mote operation will return if the battery recharges to 2.3 V. If the batteries are unable to be recharged, replace them with fresh rechargeable batteries. **Note:** if you install used rechargeable batteries that together are less than 2.3 V, the mote will not resume operation.



To replace rechargeable batteries:

1. Open the mote door.
2. Remove the old batteries and install fresh ones observing polarity.
3. Make sure the solar panel cable is plugged in.

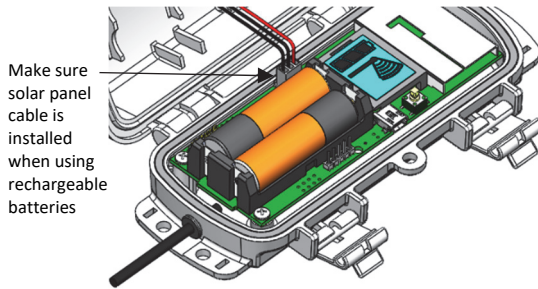

The mote contacts the network once the new batteries are installed. The green LED blinks during this process while the bars in the signal strength indicator on the LCD cycle from left to right and then the x icon blinks. Once this process is complete, the x icon is removed, the green LED stops blinking, and the blue LED begins blinking instead.

### **Lithium Batteries**

You can use two 1.5 V lithium batteries (HWSB-LI) for operation at the extreme ends of the mote operating range. Lithium battery life is an estimated at 1 year, but varies based on the ambient temperature where the mote is deployed, the logging interval, the number of tripped alarms, and other factors. Estimates are not guaranteed due to uncertainties in initial battery conditions and operating environment. When using lithium batteries, you must disconnect the solar panel cable because the batteries will not be recharged.

To install lithium batteries:

1. Open the mote door.
2. Remove any old batteries and install the new ones observing polarity.
3. Push in the side tab of the solar panel cable connector and pull the connector out of the cable port.
4. Place the connector in the slot on the inside of the mote door. Make sure the solar panel cables are tucked inside the door so that they do not interfere with the interior seal when the mote is closed.

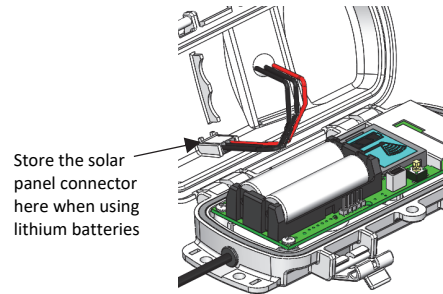

The mote contacts the network once the new batteries are installed. The green LED blinks quickly while the mote searches for a network to join and then blinks slowly while it completes the network registration. Once the mote has finished joining the network, the green LED turns off and the blue LED then blinks indefinitely while the mote is part of the network.

**⚠ WARNING:** Do not cut open, incinerate, heat above 85°C (185°F), or recharge the lithium batteries. The batteries may explode if the mote is exposed to extreme heat or conditions that could damage or destroy the battery cases. Do not mix battery types, either by chemistry or age; batteries may rupture or explode. Do not dispose of the logger or batteries in fire. Do not expose the contents of the batteries to water. Dispose of the batteries according to local regulations for lithium batteries.

---

#### Federal Communication Commission Interference Statement

This equipment has been tested and found to comply with the limits for a Class B digital device, pursuant to Part 15 of the FCC Rules. These limits are designed to provide reasonable protection against harmful interference in a residential installation. This equipment generates, uses, and can radiate radio frequency energy and, if not installed and used in accordance with the instructions, may cause harmful interference to radio communications. However, there is no guarantee that interference will not occur in a particular installation. If this equipment does cause harmful interference to radio or television reception, which can be determined by turning the equipment off and on, the user is encouraged to try to correct the interference by one of the following measures:

- Reorient or relocate the receiving antenna
- Increase the separation between the equipment and receiver
- Connect the equipment into an outlet on a circuit different from that to which the receiver is connected
- Consult the dealer or an experienced radio/TV technician for help

This device complies with Part 15 of the FCC Rules. Operation is subject to the following two conditions: (1) This device may not cause harmful interference, and (2) this device must accept any interference received, including interference that may cause undesired operation.

**FCC Caution:** Any changes or modifications not expressly approved by the party responsible for compliance could void the user's authority to operate this equipment.

#### Industry Canada Statements

This device complies with Industry Canada license-exempt RSS standard(s). Operation is subject to the following two conditions: (1) this device may not cause interference, and (2) this device must accept any interference, including interference that may cause undesired operation of the device.

#### Avis de conformité pour l'Industrie Canada

Le présent appareil est conforme aux CNR d'Industrie Canada applicables aux appareils radio exempts de licence. L'exploitation est autorisée aux deux conditions suivantes : (1) l'appareil ne doit pas produire de brouillage, et (2) l'appareil doit accepter tout brouillage radioélectrique subi, même si le brouillage est susceptible d'en compromettre le fonctionnement.

To comply with FCC and Industry Canada RF radiation exposure limits for general population, the logger must be installed to provide a separation distance of at least 20cm from all persons and must not be co-located or operating in conjunction with any other antenna or transmitter.

#### NCC Statement

經型式認證合格之低功率射頻電機，非經許可，公司、商號或使用者均不得擅自變更頻率、加大功率或變更原設計之特性及功能。

低功率射頻電機之使用不得影響飛航安全及干擾合法通信；經發現有干擾現象時，應立即停用，並改善至無干擾時方得繼續使用。前項合法通信，指依電信法規定作業之無線電通信。低功率射頻電機須忍受合法通信或工業、科學及醫療用電波輻射性電機設備之干擾。

#### Translation:

#### Article 12

Without permission granted by the NCC, any company, enterprise, or user is not allowed to change frequency, enhance transmitting power or alter original characteristic as well as performance to an approved low power radio-frequency device.

#### Article 14

The low power radio-frequency devices shall not influence aircraft security and interfere with legal communications. If found, the user shall cease operating immediately until no interference is achieved. The said legal communications means radio communications is operated in compliance with the Telecommunications Act. The low power radio-frequency devices must be susceptible with the interference from legal communications or ISM radio wave radiated devices.